

## Superglass Insulation Ltd

Thistle Industrial Estate  
Kerse Road  
Stirling FK7 7QQ

Tel: 01786 451170 Fax: 01786 451245

e-mail: technical@superglass.co.uk

website: www.superglass.co.uk



**Agrément Certificate**

**89/2231**

Product Sheet 3

### SUPERGLASS CAVITY WALL INSULATION

### SUPERWALL 32 DUAL PURPOSE CAVITY WALL BATT

This Agrément Certificate Product Sheet<sup>(1)</sup> relates to Superwall 32 Dual Purpose Cavity Wall Batt, an unfaced glass mineral wool batt for use as full or partial fill thermal insulation in new external masonry cavity walls, up to 25 metres in height for full fill and without restriction for partial fill, in new buildings of a domestic and non-domestic nature (additional requirements apply for buildings above 12 metres in height for full fill and above 25 metres in height for partial fill). The product is installed during construction.

(1) Hereinafter referred to as 'Certificate'.

#### CERTIFICATION INCLUDES:

- factors relating to compliance with Building Regulations where applicable
- factors relating to additional non-regulatory information where applicable
- independently verified technical specification
- assessment criteria and technical investigations
- design considerations
- installation guidance
- regular surveillance of production
- formal three-yearly review.

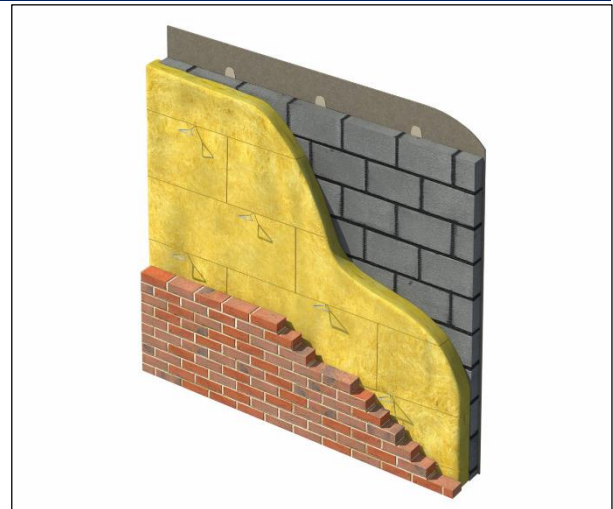

#### KEY FACTORS ASSESSED

**Thermal performance** — the product has a declared thermal conductivity ( $\lambda_D$ ) of  $0.032 \text{ W}\cdot\text{m}^{-1}\cdot\text{K}^{-1}$  (see section 6).

**Water resistance** — the product will resist the transfer of water across the cavity (see section 7).

**Condensation risk** — the product can contribute to limiting the risk of condensation (see section 8).

**Behaviour in relation to fire** — use of the product does not prejudice the fire resistance properties of the wall (see section 9).

**Durability** — the product is durable, rot proof, water resistant and sufficiently stable to remain effective as insulation for the life of the building (see section 11).



The BBA has awarded this Certificate to the company named above for the product described herein. This product has been assessed by the BBA as being fit for its intended use provided it is installed, used and maintained as set out in this Certificate.

On behalf of the British Board of Agrément

Date of Second issue: 7 September 2017

John Albon – Head of Approvals  
Construction Products

Claire Curtis-Thomas  
Chief Executive

Originally certificated on 20 September 2011

Certificate amended on 6 May 2021 to include reinforced concrete.

*The BBA is a UKAS accredited certification body – Number 113.*

*The schedule of the current scope of accreditation for product certification is available in pdf format via the UKAS link on the BBA website at [www.bbacerts.co.uk](http://www.bbacerts.co.uk)  
Readers MUST check the validity and latest issue number of this Agrément Certificate by either referring to the BBA website or contacting the BBA directly.*

*Any photographs are for illustrative purposes only, do not constitute advice and should not be relied upon.*

#### British Board of Agrément

Bucknalls Lane  
Watford  
Herts WD25 9BA

©2017

tel: 01923 665300  
[clientservices@bbacerts.co.uk](mailto:clientservices@bbacerts.co.uk)  
[www.bbacerts.co.uk](http://www.bbacerts.co.uk)

## Regulations

In the opinion of the BBA, Superwall 32 Dual Purpose Cavity Wall Batt, if installed, used and maintained in accordance with this Certificate, can satisfy or contribute to satisfying the relevant requirements of the following Building Regulations (the presence of a UK map indicates that the subject is related to the Building Regulations in the region or regions of the UK depicted):



### The Building Regulations 2010 (England and Wales) (as amended)

<b>Requirement:</b>	<b>B3(4)</b>	<b>Internal fire spread (structure)</b>
Comment:		The product can contribute to satisfying this Requirement. See section 9 of this Certificate.
<b>Requirement:</b>	<b>C2(a)</b>	<b>Resistance to moisture</b>
Comment:		The product can contribute to satisfying this Requirement. See section 7.1 of this Certificate.
<b>Requirement:</b>	<b>C2(b)</b>	<b>Resistance to moisture</b>
Comment:		The product can contribute to satisfying this Requirement. See section 7.2 of this Certificate.
<b>Requirement:</b>	<b>C2(c)</b>	<b>Resistance to moisture</b>
Comment:		The product can contribute to satisfying this Requirement. See sections 8.1 and 8.4 of this Certificate.
<b>Requirement:</b>	<b>L1(a)(i)</b>	<b>Conservation of fuel and power</b>
Comment:		The product can contribute to satisfying this Requirement. See section 6 of this Certificate.
<b>Regulation:</b>	<b>7</b>	<b>Materials and workmanship</b>
Comment:		The product is an acceptable material. See section 11 and the <i>Installation</i> part of this Certificate.
<b>Regulation:</b>	<b>26</b>	<b>CO<sub>2</sub> emission rates for new buildings</b>
<b>Regulation:</b>	<b>26A</b>	<b>Fabric energy efficiency rates for new dwellings (applicable to England only)</b>
<b>Regulation:</b>	<b>26A</b>	<b>Primary energy consumption rates for new buildings (applicable to Wales only)</b>
<b>Regulation:</b>	<b>26B</b>	<b>Fabric performance values for new dwellings (applicable to Wales only)</b>
Comment:		The product can contribute to satisfying these Regulations. See section 6.2 of this Certificate.



### The Building (Scotland) Regulations 2004 (as amended)

<b>Regulation:</b>	<b>8(1)</b>	<b>Durability, workmanship and fitness of materials</b>
Comment:		The product can contribute to a construction satisfying this Regulation. See section 11 and the <i>Installation</i> part of this Certificate.
<b>Regulation:</b>	<b>9</b>	<b>Building standards applicable to construction</b>
Standard:	<b>2.4</b>	Cavities
Comment:		The product can contribute to a construction satisfying this Standard, with reference to clause 2.4.2 <sup>(1)(2)</sup> . See section 9 of this Certificate.
Standard:	<b>2.6</b>	Spread to neighbouring buildings
Comment:		The product is non-combustible and can contribute to satisfying the requirements of this Standard, with reference to clauses 2.6.5 <sup>(1)</sup> and 2.6.6 <sup>(2)</sup> . See section 9 of this Certificate.
Standard:	<b>3.4</b>	Moisture from the ground
Comment:		The product can contribute to a construction satisfying this Standard, with reference to clauses 3.4.1 <sup>(1)(2)</sup> and 3.4.5 <sup>(1)(2)</sup> . See section 7.1 of this Certificate.

Standard:	3.10	Precipitation
Comment:		The product can contribute to satisfying this Standard, with reference to clauses 3.10.1 <sup>(1)(2)</sup> and 3.10.3 <sup>(1)(2)</sup> provided it complies with the conditions in section 7.2 of this Certificate.
Standard:	3.15	Condensation
Comment:		The product can contribute to satisfying this Standard, with reference to clauses 3.15.1 <sup>(1)(2)</sup> , 3.15.4 <sup>(1)(2)</sup> and 3.15.5 <sup>(1)(2)</sup> . See sections 8.1 and 8.5 of this Certificate.
Standard:	6.1(b)	Carbon dioxide emissions
Standard:	6.2	Building insulation envelope
Comment:		This product can contribute to satisfying clauses, or parts of, 6.1.1 <sup>(1)</sup> , 6.1.2 <sup>(2)</sup> , 6.1.6 <sup>(1)</sup> , 6.2.1 <sup>(1)(2)</sup> , 6.2.3 <sup>(1)</sup> , 6.2.4 <sup>(2)</sup> , 6.2.5 <sup>(2)</sup> , 6.2.9 <sup>(1)</sup> , 6.2.10 <sup>(1)</sup> , 6.2.11 <sup>(2)</sup> and 6.2.13 <sup>(2)</sup> of these Standards. See section 6 of this Certificate.
Standard:	7.1(a)(b)	Statement of sustainability
Comment:		The product can contribute to satisfying the relevant requirements of Regulation 9, Standards 1 to 6, and therefore will contribute to a construction meeting a bronze level of sustainability as defined in this Standard. In addition, the product can contribute to a construction meeting a higher level of sustainability as defined in this Standard, with reference to clauses 7.1.4 <sup>(1)(2)</sup> [Aspects 1 <sup>(1)(2)</sup> and 2 <sup>(1)</sup> ], 7.1.6 <sup>(1)(2)</sup> [Aspects 1 <sup>(1)(2)</sup> and 2 <sup>(1)</sup> ] and 7.1.7 <sup>(1)(2)</sup> [Aspect 1 <sup>(1)(2)</sup> ]. See section 6.1 of this Certificate.
<b>Regulation:</b>	<b>12</b>	<b>Building standards applicable to conversions</b>
Comment:		All comments given for the product under Regulation 9, Standards 1 to 6, also apply to this Regulation, with reference to clause 0.12.1 <sup>(1)(2)</sup> and Schedule 6 <sup>(1)(2)</sup> .
		(1) Technical Handbook (Domestic). (2) Technical Handbook (Non-Domestic).



## The Building Regulations (Northern Ireland) 2012 (as amended)

<b>Regulation:</b>	<b>23</b>	<b>Fitness of materials and workmanship</b>
Comment:		The product is an acceptable material. See section 11 and the <i>Installation</i> part of this Certificate.
<b>Regulation:</b>	<b>28(a)</b>	<b>Resistance to moisture and weather</b>
Comment:		The product can contribute to a construction satisfying this Regulation. See section 7.1 of this Certificate.
<b>Regulation:</b>	<b>28(b)</b>	<b>Resistance to moisture and weather</b>
Comment:		The product can contribute to satisfying this Regulation. See section 7.2 of this Certificate.
<b>Regulation:</b>	<b>29</b>	<b>Condensation</b>
Comment:		The product can contribute to satisfying this Regulation. See section 8.1 of this Certificate.
<b>Regulation:</b>	<b>35(4)</b>	<b>Internal fire spread – structure</b>
Comment:		The product can contribute to satisfying this Regulation. See section 9 of this Certificate.
<b>Regulation:</b>	<b>39(a)(i)</b>	<b>Conservation measures</b>
<b>Regulation:</b>	<b>40(2)</b>	<b>Target carbon dioxide emission rate</b>
Comment:		The product can contribute to satisfying these Regulations. See section 6 of this Certificate.

# Construction (Design and Management) Regulations 2015

## Construction (Design and Management) Regulations (Northern Ireland) 2016

Information in this Certificate may assist the client, designer (including Principal Designer) and contractor (including Principal Contractor) to address their obligations under these Regulations.

See section: 3 *Delivery and site handling* (3.4) of this Certificate.

### Additional Information

#### NHBC Standards 2017

In the opinion of the BBA, Superwall 32 Dual Purpose Cavity Wall Batt, if installed, used and maintained in accordance with this Certificate, can satisfy or contribute to satisfying the relevant requirements in relation to *NHBC Standards*, Chapter 6.1 *External masonry walls*.

#### CE marking

The Certificate holder has taken the responsibility of CE marking the product in accordance with harmonised European Standard BS EN 13162 : 2015. An asterisk (\*) appearing in this Certificate indicates that data shown are given in the manufacturer's Declaration of Performance.

### Technical Specification

#### 1 Description

Superwall 32 Dual Purpose Cavity Wall Batt consists of layers of bonded, water-repellent-treated glass wool, formed into resilient batts using a resin binder, with the nominal characteristics given in Table 1.

Table 1 Nominal characteristics

Characteristic (unit)	Value
Length (mm)	1200
Width (mm)	455
Thickness (mm) <sup>(1)</sup>	50 to 150

(1) In 5 mm increments.

#### 2 Manufacture

2.1 Raw materials, mixed to a controlled formulation, are melted in a furnace to produce molten glass. Glass fibres are produced from the molten glass using a rotary spinning process. The fibres are treated with a resin and formed into a continuous length of insulation to the required thickness. The insulation then passes into an oven which cures the resin. The insulation is then cut to the required dimensions to form the batts.

2.2 As part of the assessment and ongoing surveillance of product quality, the BBA has:

- agreed with the manufacturer the quality control procedures and product testing to be undertaken
- assessed and agreed the quality control operated over batches of incoming materials
- monitored the production process and verified that it is in accordance with the documented process
- evaluated the process for management of nonconformities
- checked that equipment has been properly tested and calibrated
- undertaken to carry out the above measures on a regular basis through a surveillance process, to verify that the specifications and quality control operated by the manufacturer are being maintained.

2.3 The management systems of Superglass Insulation Ltd have been assessed and registered as meeting the requirements of BS EN ISO 9001 : 2015 by BSI (Certificate FM 02264) and in BS EN ISO 14001 : 2015 (Certificate EMS 646508).

### 3 Delivery and site handling

3.1 Each pack carries a label bearing the manufacturer's name and product description. The polythene packaging carries the BBA logo incorporating the number of this Certificate. Essential instructions for installation can be found on the Certificate holder's website.

3.2 The product is supplied compression packed in polythene to provide short-term protection. For long-term protection, the product must be stored indoors or under a waterproof covering to protect it from weather damage. The product should not be left permanently exposed to the elements.

3.3 Partially completed walls should be protected from inclement weather (eg wind, rain or snow) and covered at the end of the day's work.

3.4 It is recommended that dust masks, gloves and long-sleeved clothing are worn during the cutting and handling of the product.

## Assessment and Technical Investigations

The following is a summary of the assessment and technical investigations carried out on Superwall 36 Dual Purpose Cavity Wall Batt.

## Design Considerations

### 4 Use

4.1 Superwall 32 Dual Purpose Cavity Wall Batt is satisfactory for use as either a full fill or partial fill cavity wall insulation and is used to reduce the thermal transmittance (U value) of external cavity walls with masonry inner and outer leaves (where masonry includes clay and calcium silicate bricks, concrete blocks, reinforced concrete and natural and reconstituted stone blocks). The product is for use in new domestic and non-domestic buildings up to and including 25 metres in height for full fill and without restriction for partial fill (although additional requirements apply above 12 metres in height for full fill and above 25 metres for partial fill). It is essential that walls are designed and constructed to incorporate the precautions given in this Certificate to prevent moisture penetration.

4.2 This Certificate covers the use of the product for full fill in any exposure zone (see section 4.10 for partial fill restrictions). However, use of the product does not preclude the need to apply any external render coat or other suitable finish in severe exposure zones where such application would be normal practice.

4.3 As with other forms of cavity wall insulation, where buildings need to comply with *NHBC Standards*, specifiers should observe the requirements of that document.

4.4 Buildings subject to the national Building Regulations should be constructed in accordance with the relevant recommendations of:

- BS EN 1996-1-1 : 2005, BS EN 1996-1-2 : 2005, BS EN 1996-2 : 2006 and BS EN 1996-3 : 2006 and their respective UK National Annexes
- BS EN 845-1 : 2013 and BS 8000-3 : 2001.

4.5 New buildings not subject to regulatory requirements should also be built in accordance with the Standards identified in section 4.4 of this Certificate.

4.6 Cavity wall ties and, if required, any additional ties to BS EN 845-1 : 2013 should be used for structural stability in accordance with BS EN 1996-1-1 : 2005, BS EN 1996-2 : 2006 and BS EN 1996-3 : 2006.

4.7 Care must be taken in the overall design and construction of walls incorporating the product to ensure the provision of appropriate:

- cavity trays and damp-proof courses (dpc's)
- cavity barriers and fire dampers
- resistance to the ingress of precipitation, moisture and dangerous gases from the ground
- resistance to sound transmission when flanking separating walls and floors.

4.8 In partial fill application, the use of cavity battens or boards is strongly recommended to prevent thermal bridging by mortar droppings.

**Full fill use**

**Buildings over 12 metres high and up to and including 25 metres high**

4.9 Where the walls of a building are between 12 and 25 metres high, the following requirements also apply:

- from ground level, the maximum height of continuous cavity must not exceed 12 metres. Above 12 metres, the maximum height of continuous cavity must not exceed 7 metres. In both cases, breaks should be in the form of continuous horizontal cavity trays and weepholes discharging to the outside
- the area to be insulated must not be an infill panel in a framed structure
- the Certificate holder, in association with the architect, must carry out a detailed programme of assessment of the project including an examination of the quality of installation as work progresses. Above average site supervision is recommended during installation.

**Partial fill use**

**Buildings up to and including 25 metres high**

4.10 The residual cavity width to be maintained during construction is 50 mm. This may reduce to 25 mm in isolated areas due to individual construction features (a minimum of 50 mm residual cavity width is required by the NHBC). This may be achieved by designing a cavity width which takes into account the dimensional tolerances of the components which make up the wall (by reference to the British Standards relating to the bricks, blocks and batts), or by using the data from the respective manufacturers. Allowances may need to be made for the quality of building operatives and the degree of site supervision or control available, and for the limitations in respect of exposure of the proposed building (as set out in Table 2).

*Table 2 Maximum allowable total exposure factors of different constructions*

Construction	Maximum allowable exposure factor $E^{(1)}$
All external masonry walls protected by: rendering (to BS EN 13914-1 : 2016), tile/slate hanging or timber, plastic or metal weatherboarding or cladding	No restriction
One or more external masonry walls constructed from facing clay brickwork or natural stone (the porosity of which exceeds 20% by volume). Mortar joints must be flush-pointed or weatherstruck	100
One or more external masonry walls constructed from calcium silicate bricks, concrete blocks, reinforced concrete and reconstituted stone, or natural stone (the porosity of which is less than 20% by volume), or any material with raked mortar joints	88

1) To BS 5618 : 1985.

4.11 From ground level, the maximum height of continuous cavity walls must not exceed 12 metres; above 12 metres, the maximum height of continuous cavity walls must not exceed 7 metres. In both cases, breaks should be in the form of continuous horizontal cavity trays and weepholes discharging to the outside.

4.12 An external render coat or other suitable finish should be applied in locations where such application would be normal practice; care should be taken to ensure that the residual cavity is not bridged by mortar.

4.13 The use of cavity battens or boards is strongly recommended to prevent thermal bridging by mortar droppings.

### Buildings over 25 metres in height

4.14 The width of the residual clear cavity to be achieved is to be in excess of 50 mm, and the following additional requirements apply:

- the specifier must take extra care when detailing to ensure that the introduction of the insulation does not affect the weather resistance of the wall. Above average site supervision is recommended during installation of the product
- where, for structural reasons, the cavity width is reduced, eg by the intrusion of ring beams, a minimum residual cavity width of 25 mm must be maintained and extra care must be taken with fixings and weatherproofing, eg the inclusion of cavity trays with weepholes.

## 5 Practicability of installation

The product is designed to be installed by a competent general builder, or a contractor, experienced with this type of product.

## 6 Thermal performance



6.1 Calculations of the thermal transmittance (U value) of specific external wall constructions should be carried out in accordance with BS EN ISO 6946 : 2017 and BRE Report BR 443 : 2019, using the declared thermal conductivity ( $\lambda_D$ )\* of 0.032 W·m<sup>-1</sup>·K<sup>-1</sup>.

6.2 The U value of a completed wall will depend on the insulation thickness, number and type of fixings, the insulating value of the substrate masonry and its internal finish. Calculated U values for example constructions are given in Tables 3 and 4.

Table 3 Example U values<sup>(1)</sup> — full fill

U value requirement (W·m <sup>-2</sup> ·K <sup>-1</sup> )	Insulation thickness (mm)	
	100 mm dense block <sup>(2)</sup> 13 mm dense plaster <sup>(4)</sup>	100 mm AAC block <sup>(3)</sup> Plasterboard on dabs
0.18	175	150
0.19	165	140
0.25	125	95
0.26	120	90
0.27	115	85
0.28	110	80
0.30	100	75
0.35	85	55

(1) Assumes air gap correction,  $\Delta U = 0.01$ . Assumes fixings correction for fully penetrating steel fixings (50 W·m<sup>-1</sup>·K<sup>-1</sup>) at 2.5 m<sup>2</sup> with cross-sectional area of 12.5 mm<sup>2</sup>. Construction includes 102.5 mm thick brick outer leaf.

(2) Dense block and mortar thermal conductivity 1.13 W·m<sup>-1</sup>·K<sup>-1</sup> and 0.88 W·m<sup>-1</sup>·K<sup>-1</sup> respectively.

(3) AAC block and mortar thermal conductivity 0.12 W·m<sup>-1</sup>·K<sup>-1</sup> and 0.88 W·m<sup>-1</sup>·K<sup>-1</sup> respectively.

(4) Plaster thermal conductivity 0.57 W·m<sup>-1</sup>·K<sup>-1</sup>.

(5) Plasterboard thermal conductivity 0.25 W·m<sup>-1</sup>·K<sup>-1</sup>.

Table 4 Example U values<sup>(1)</sup> — partial fill

U value requirement (W·m <sup>-2</sup> ·K <sup>-1</sup> )	Insulation thickness (mm)	
	100 mm dense block <sup>(2)</sup> 13 mm dense plaster <sup>(4)</sup>	100 mm AAC block <sup>(3)</sup> Plasterboard on dabs
0.18	170	145
0.19	160	135
0.25	115	90
0.26	110	85
0.27	105	80
0.28	100	75
0.30	95	70
0.35	80	50

(1) Assumes air gap correction,  $\Delta U = 0.01$ . Assumes fixings correction for fully penetrating steel fixings ( $50 \text{ W}\cdot\text{m}^{-1}\cdot\text{K}^{-1}$ ) at  $2.5 \text{ m}^2$  with cross-sectional area of  $12.5 \text{ mm}^2$ . Construction includes 102.5 mm thick brick outer leaf.

(2) Dense block and mortar thermal conductivity  $1.13 \text{ W}\cdot\text{m}^{-1}\cdot\text{K}^{-1}$  and  $0.88 \text{ W}\cdot\text{m}^{-1}\cdot\text{K}^{-1}$  respectively.

(3) AAC block and mortar thermal conductivity  $0.12 \text{ W}\cdot\text{m}^{-1}\cdot\text{K}^{-1}$  and  $0.88 \text{ W}\cdot\text{m}^{-1}\cdot\text{K}^{-1}$  respectively.

(4) Plaster thermal conductivity  $0.57 \text{ W}\cdot\text{m}^{-1}\cdot\text{K}^{-1}$ .

(5) Plasterboard thermal conductivity  $0.25 \text{ W}\cdot\text{m}^{-1}\cdot\text{K}^{-1}$ .

## Junctions



6.3 The product can contribute to maintaining continuity of thermal insulation at junctions with other elements and minimise thermal bridges and air infiltration. Detailed guidance can be found in the documents supporting the national Building Regulations. Advice can also be sought from the Certificate holder

## 7 Water resistance



7.1 The product may be used in situations where it bridges the dpc in walls. Dampness from the ground will not pass through to the inner leaf provided the wall is detailed in accordance with the requirements and provisions of the national Building Regulations.

7.2 Constructions incorporating the product and built in accordance with the Standards listed in section 4.4, will resist the transfer of precipitation to the inner leaf and satisfy the national Building Regulations.

7.3 In all situations, it is particularly important to ensure during installation that:

- installation is carried out to the highest level on each wall, or the top edge of the insulation is protected by a cavity tray
- cavity trays are used with appropriate stop ends and weep holes at lintel level
- cavity battens and/or boards are used during construction to prevent bridging by mortar droppings
- wall ties are installed correctly and are thoroughly clean
- excess mortar is cleaned from the cavity face of the leading leaf and any debris removed from the cavity
- mortar droppings are cleaned from the exposed edges of installed batts
- dpc's at ground level do not project into the cavity as they can form a trap for mortar bridging
- insulation batts are properly installed and butt-jointed
- raked or recessed mortar joints are avoided in very severe exposure areas.

7.4 Window and door opening reveals should be constructed incorporating a cavity barrier/closer/dpc, as required.



## 8 Condensation risk

### Interstitial condensation



8.1 Walls will adequately limit the risk of interstitial condensation when they are designed and constructed in accordance with BS 5250 : 2011, Annexes D and G, and the relevant guidance.

8.2 The product has a nominal vapour resistivity of 7 to 10 MN·s·g<sup>-1</sup>·m<sup>-1</sup>.

8.3 If the product is to be used in the external walls of rooms expected to have high humidity, care must be taken to provide adequate permanent ventilation to avoid possible problems from the formation of interstitial condensation.

### Surface condensation



8.4 Walls will adequately limit the risk of surface condensation when the thermal transmittance (U value) does not exceed 0.7 W·m<sup>-2</sup>·K<sup>-1</sup> at any point and the junctions with other elements are designed in accordance with the guidance referred to in section 6.3.



8.5 For buildings in Scotland, constructions will be acceptable where the thermal transmittance (U value) does not exceed 1.2 W·m<sup>-2</sup>·K<sup>-1</sup> at any point and the junctions with other elements are designed in accordance with the guidance referred to in BS 5250 : 2011, Annex G. Further guidance may be obtained from BRE Report BR 262 : 2002 and section 6.3 of this Certificate.

## 9 Behaviour in relation to fire



The product has a reaction to fire classification\* of Class A1 to BS EN 13501-1 : 2007; therefore, it is considered to be non-combustible under the national Building Regulations.

## 10 Maintenance

As the product is confined within the wall cavity and has suitable durability (see section 11), maintenance is not required.

## 11 Durability



The product is unaffected by the normal conditions in a wall, and is durable, rot proof, water resistant and sufficiently stable to remain effective as insulation for the life of the building.

## Installation

### 12 General

12.1 The Certificate holder will provide on-site demonstrations on request, to ensure correct installation from the outset.

12.2 Adequate supervision of the installation should be maintained and the Certificate holder must have right of access to site to ensure correct installation.

12.3 It is recommended that the external leaf is constructed ahead of the internal leaf so that any mortar protruding into the cavity space from the back of the external leaf can be cleaned off before installing the product. Batts must not be pushed into a completed cavity.

12.4 Vertical joints in the batts must be staggered and all joints tightly butted. Where protrusions occur in the cavity, the batts should be carefully cut to fit.

12.5 If installation of the batts is terminated below the highest level of the wall, the top edge of the insulation must be protected by a cavity tray and alternate perpend joints raked out, to provide adequate drainage of water from this tray.

12.6 Where required, door and window reveals should incorporate a cavity barrier/closer. It is recommended that BBA-approved cavity barriers/closers are used.

## 13 Procedure

### Full fill or partial fill

13.1 A section of the inner leaf is built, with the first row of wall ties, at maximum 600 mm horizontal spacing, where the insulation is to begin. It is recommended that the wall ties are not placed directly on the dpc. The first run of batts may commence below the dpc level to provide some edge insulation for the floor.

13.2 The leading leaf is then built up to the required height, with wall ties placed at a vertical spacing of 450 mm ensuring the drip of the tie is located halfway across the residual cavity width. Excess mortar should be cleaned from the cavity face of the leading leaf, and the batts placed on the wall ties behind the retaining clips, to form a closely butt-jointed run.

13.3 The batt is compressed slightly and placed between the upper and lower wall ties (see Figure 1) to form a closely butt-jointed run.

*Figure 1 Installation of batts between upper and lower wall ties*

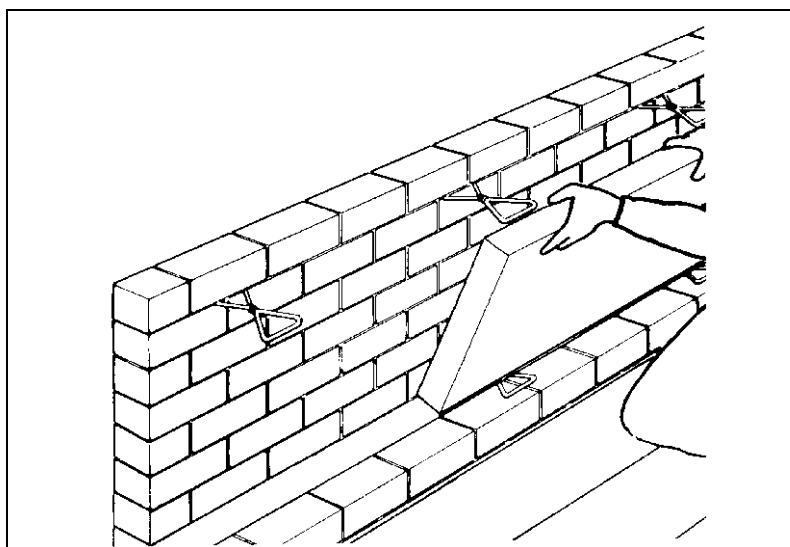

13.4 The drip on each of the upper wall ties is inserted into the top of the batt and must be positioned to shed water away from the inner leaf. This is important to ensure that it functions correctly.

13.5 The other leaf is built up to the same level as the batt, with its inner face in contact with the batts.

13.6 Successive sections of the wall, incorporating wall ties, are constructed and the batt installed as work proceeds up to the required height. Vertical joints must be staggered and all joints tightly butted. Where protrusions occur in the cavity or extra wall ties are used, the batt should be carefully cut to fit.

13.7 For wide cavities, it is possible to use two layers of batts with vertical joints staggered both between layers and within layers. Appropriate wall ties should be used to accommodate the extra width of cavity; if unequal thicknesses of batts are used, the thinner layer should be placed nearest the outer brick leaf.

13.8 Batt should be installed to the highest level of each wall (see section 12.5).

13.9 Additional wall ties may be required to satisfy the structural requirements of BS EN 845-1 : 2013, BS EN 1996-1-1 : 2005, BS EN 1996-2 : 2006 and BS EN 1996-3 : 2006 to ensure adequate retention of the product or cut pieces.

13.10 Where additional ties are required at less than 450 mm vertical spacing, the batts must be cut and neatly fitted around them. Under no circumstances should the batts be impaled by the ties.

### Partial fill only

13.11 It is recommended that the inner leaf be constructed ahead of the outer leaf, as the batts are fastened to the cavity face of the inner leaf. It is essential that the spacing of wall ties/clips allows one long edge of each batt to be secured at a minimum of two points.

13.12 The leading leaf is then built up to the required height, with wall ties placed at a vertical spacing of 450 mm, ensuring the drip of the tie is located halfway across the residual cavity width. Excess mortar should be cleaned from the cavity face of the leading leaf, and the batts placed on the wall ties behind the retaining clips, to form a closely butt-jointed run.

13.13 The second row of wall ties is fitted to retain the tops of the batts. It is essential that all wall ties slope downwards towards the outer leaf (see Figure 2), and are placed at centres not exceeding 900 mm<sup>(1)</sup> to ensure that each batt is secured at a minimum of three points. The first row of insulation batts must not be in contact with the ground.

(1) Where buildings need to comply with NHBC Standards, the spacing should be no more than 600 mm.

Figure 2 Partial fill wall tie detail

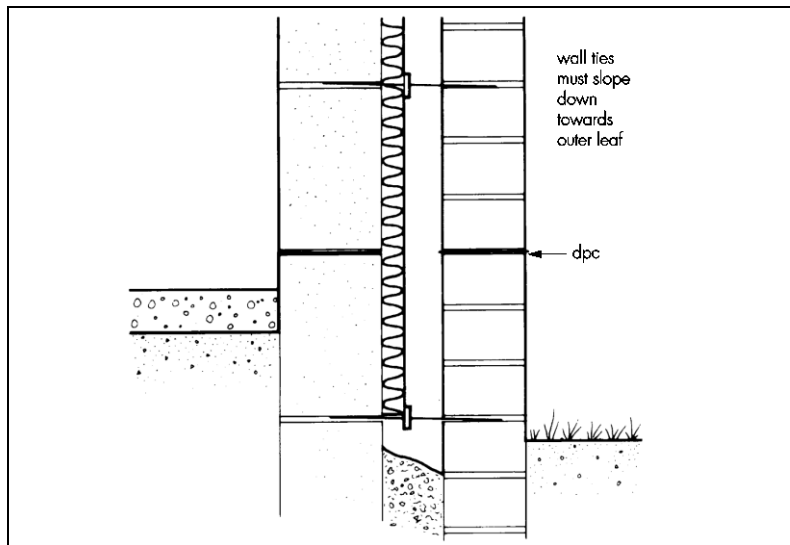

### Mortar droppings

13.14 After each section of the wall leaf is built, excess mortar should be removed from the cavity and mortar droppings cleaned from exposed edges of the installed batt before installation of the next section of batts. Use of a cavity board is recommended to protect batt edges and make cleaning easier (see Figure 3). For partial fill, a cavity batten will protect the installed batts and help keep the cavity clean as the following leaf is built (see Figure 4).

Figure 3 Use of a cavity board when clearing off mortar

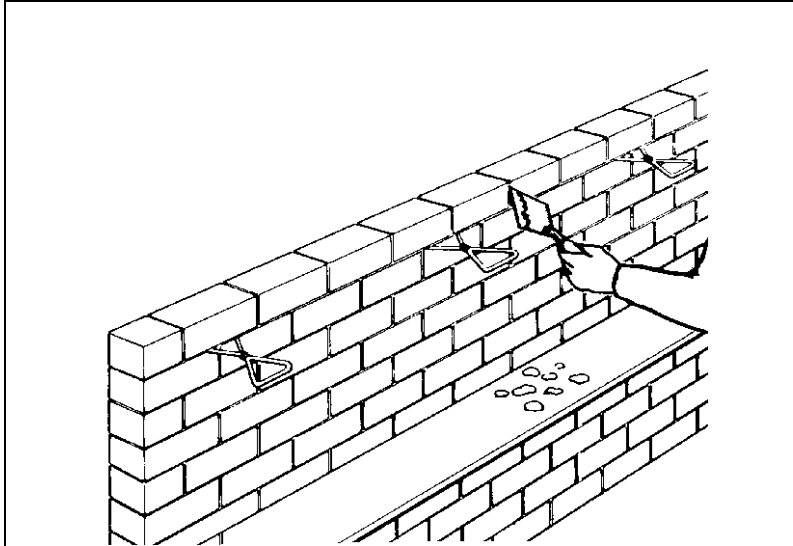
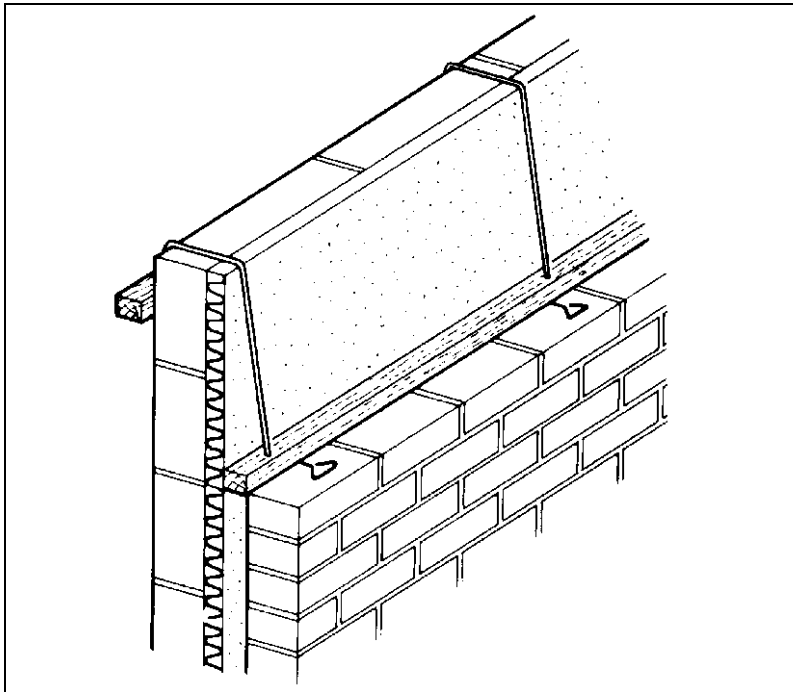

Figure 4 Use of a cavity batt — partial fill only



### Corners

13.15 It is recommended that the thinner batts (50 to 75 mm) are bent round corners (see Figures 5 and 6). Thicker batts should be close butt jointed at corners to avoid cold bridges.

Figure 5 Batts bent round corners — full fill

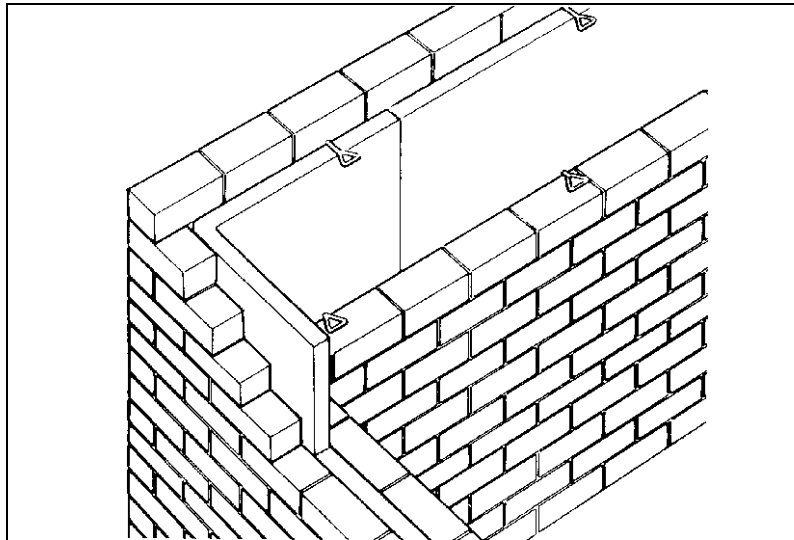
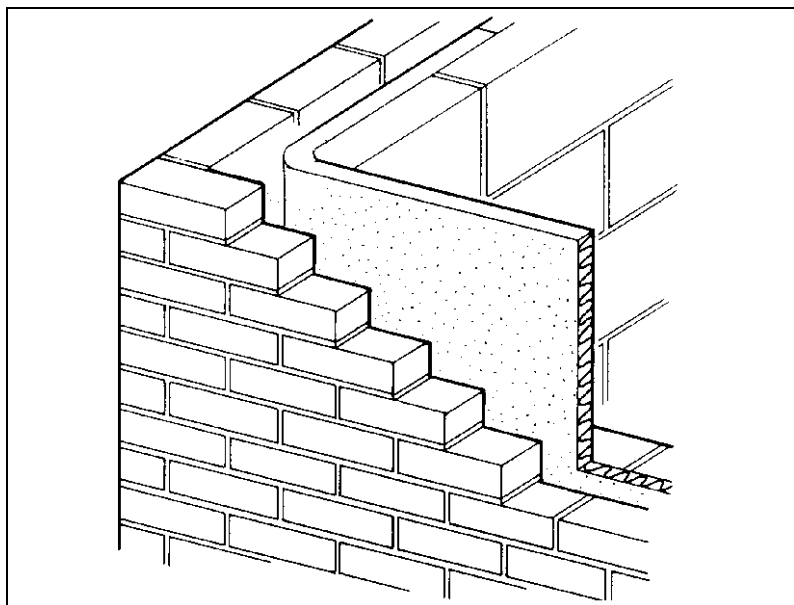

Figure 6 Batts bent round corners— partial fill



### Wall openings

13.16 Where openings such as doors and windows are in close proximity, it is recommended that a continuous lintel or cavity tray is used. Individual lintels or cavity trays should have stopends and be adequately drained. Insulation batts should be cut to butt tightly against the cavity barrier/closer/dpc.

### Cut pieces

13.17 Batts can be cut, using a sharp knife or fine-toothed saw, to fit around windows, doors, apertures, air bricks etc. It is essential that cut pieces completely fill the spaces for which they are intended and that no gaps are left in the insulation.

13.18 Small pieces must be fitted with the fibre orientation parallel to the plane of the wall.

### Protection

13.19 Exposed areas of batts should always be covered at the end of the day's work or in driving rain.

13.20 All building involving the product, particularly interrupted work, must conform to BS EN 1996-2 : 2006, Clauses 3.2 *Acceptance, handling and storage of materials* and 3.6 *Curing and protective procedures during execution*.

## Technical Investigations

### 14 Tests

Results of tests were assessed to determine:

- thermal conductivity
- dimensional accuracy
- water absorption
- density of air-dry batts.

### 15 Investigations

15.1 Existing data on toxicity, durability and properties in relation to fire were evaluated.

15.2 A condensation risk analysis was carried out.

15.3 A series of U value calculations was carried out.

15.4 A calculation was undertaken to confirm the thermal conductivity ( $\lambda_D$ ).

15.5 The manufacturing process was evaluated, including the methods adopted for quality control, and details were obtained of the quality and composition of the materials used.

## Bibliography

BRE Report BR 262 : 2002 *Thermal insulation : avoiding risks*

BRE Report BR 443 : 2019 *Conventions for U-value calculations*

BS 5250 : 2011 + A1 : 2016 *Code of practice for control of condensation in buildings*

BS 5618 : 1985 *Code of practice for thermal insulation of cavity walls (with masonry or concrete inner and outer leaves) by filling with urea-formaldehyde (UF) foam systems*

BS 8000-3 : 2001 *Workmanship on building sites — Code of practice for masonry*

BS EN 845-1 : 2013 + A1 : 2016 *Specification for ancillary components for masonry — Wall ties, tension straps, hangers and brackets*

BS EN 1996-1-1 : 2005 + A1 : 2012 *Eurocode 6 — Design of masonry structures — General rules for reinforced and unreinforced masonry structures*

NA to BS EN 1996-1-1 : 2005 + A1 : 2012 *UK National Annex to Eurocode 6 — Design of masonry structures — General rules for reinforced and unreinforced masonry structures*

BS EN 1996-1-2 : 2005 *Eurocode 6 — Design of masonry structures — General rules — Structural fire design*

NA to BS EN 1996-1-2 : 2005 *UK National Annex to Eurocode 6 — Design of masonry structures — General rules — Structural fire design*

BS EN 1996-2 : 2006 *Eurocode 6 — Design of masonry structures — Design considerations, selection of materials and execution of masonry*

NA to BS EN 1996-2 : 2006 *UK National Annex to Eurocode 6 — Design of masonry structures — Design considerations, selection of materials and execution of masonry*

BS EN 1996-3 : 2006 *Eurocode 6 — Design of masonry structures — Simplified calculation methods for unreinforced masonry structures*

NA to BS EN 1996-3 : 2006 *UK National Annex to Eurocode 6 — Design of masonry structures — Simplified calculation methods for unreinforced masonry structures*

BS EN 13501-1 : 2007 + A1 : 2009 *Fire classification of construction products and building elements — Classification using test data from reaction to fire tests*

BS EN 13162 : 2015 *Thermal insulation products for buildings — Factory made mineral wool (MW) product – Specification*

BS EN 13914-1 : 2016 *Design, preparation and application of external rendering and internal plastering — External rendering*

BS EN ISO 6946 : 2017 *Building components and building elements — Thermal resistance and thermal transmittance — Calculation method*

BS EN ISO 9001 : 2015 *Quality management systems — Requirements*

BS EN ISO 14001 : 2015 *Environmental management systems — Requirements*

### 16 Conditions

#### 16.1 This Certificate:

- relates only to the product/system that is named and described on the front page
- is issued only to the company, firm, organisation or person named on the front page – no other company, firm, organisation or person may hold or claim that this Certificate has been issued to them
- is valid only within the UK
- has to be read, considered and used as a whole document – it may be misleading and will be incomplete to be selective
- is copyright of the BBA
- is subject to English Law.

16.2 Publications, documents, specifications, legislation, regulations, standards and the like referenced in this Certificate are those that were current and/or deemed relevant by the BBA at the date of issue or reissue of this Certificate.

16.3 This Certificate will remain valid for an unlimited period provided that the product/system and its manufacture and/or fabrication, including all related and relevant parts and processes thereof:

- are maintained at or above the levels which have been assessed and found to be satisfactory by the BBA
- continue to be checked as and when deemed appropriate by the BBA under arrangements that it will determine
- are reviewed by the BBA as and when it considers appropriate.

16.4 The BBA has used due skill, care and diligence in preparing this Certificate, but no warranty is provided.

16.5 In issuing this Certificate the BBA is not responsible and is excluded from any liability to any company, firm, organisation or person, for any matters arising directly or indirectly from:

- the presence or absence of any patent, intellectual property or similar rights subsisting in the product/system or any other product/system
- the right of the Certificate holder to manufacture, supply, install, maintain or market the product/system
- actual installations of the product/system, including their nature, design, methods, performance, workmanship and maintenance
- any works and constructions in which the product/system is installed, including their nature, design, methods, performance, workmanship and maintenance
- any loss or damage, including personal injury, howsoever caused by the product/system, including its manufacture, supply, installation, use, maintenance and removal
- any claims by the manufacturer relating to CE marking.

16.6 Any information relating to the manufacture, supply, installation, use, maintenance and removal of this product/system which is contained or referred to in this Certificate is the minimum required to be met when the product/system is manufactured, supplied, installed, used, maintained and removed. It does not purport in any way to restate the requirements of the Health and Safety at Work etc. Act 1974, or of any other statutory, common law or other duty which may exist at the date of issue or reissue of this Certificate; nor is conformity with such information to be taken as satisfying the requirements of the 1974 Act or of any statutory, common law or other duty of care.